



INFORMATION FOR CANDIDATES



Applicant Information Pack

Tudor Grange Academy

Solihull

Teacher of PE – Girls



Dear Applicant

Thank you for the interest you have shown in Tudor Grange Academy Solihull. We are very proud of our Academy and I regard it as a privilege to serve our community as Principal.

I consider myself to be lucky to work at a school where I enjoy coming to work each day. This is largely due to the wonderful team of staff here – both teaching and support staff. Teachers are exceptionally professional, committed and experts in their field. We benefit from being a Teaching School Hub, a Research School, a Maths Hub and a Languages Hub. This means that the professional development opportunities and opportunities for career progression are considerable. Teachers here enjoy working with colleagues to help them to develop – whether that is in the classroom, as a leader or with their own learning. Whatever stage of career you are at, there is something to help you to improve. The culture of the school is that we are all striving for continual development.

We have a strong commitment to traditional values and we have exceptionally high expectations of our students with regard to their appearance and conduct. Our aim is for learning to take place without interruption in order to allow students at Tudor Grange to make outstanding academic progress. Academic outcomes are important, but much more important is that students leave here as kind and responsible young adults. At the heart of everything we do, are the Tudor Habits and Values which are developed from Year 7 to Year 13. This involves developing the key learning habits that encourage students to be diligent, curious, resilient students equipped with the tools and mindset needed to achieve. Alongside this, we encourage the development of key character habits that help students make the right choices beyond the classroom, enabling them to lead fulfilled lives as positive, kind and responsible people.

We are incredibly proud of our excellent national reputation for academic achievement, with an excellent record of both GCSE and A Level results. In 2023 90% of students achieved a 4+ in Maths and English and 70% achieved a grade 5+ in Maths and English. 31% of GCSE grades awarded across all subjects were a 7 or above. Students who come here do exceptionally well and are excellent role models.

The academy is part of the Tudor Grange Academies Trust which is a Trust of 13 (primary and secondary) schools based in the West Midlands, Worcestershire and Leicestershire. Opportunities within the Trust are readily available to outstanding practitioners who are keen to explore career progression. As part of our commitment to CPD, we plan joint INSET days with other Academies within the Trust, to allow for meaningful collaboration.

The Senior Leadership Team at the Academy are committed to creating an environment where every student and member of staff has the opportunity to reach their potential and where the happiness and well-being of staff and students is a high priority.

I wish you every success in your application and my colleagues and I look forward to meeting the successful shortlisted candidates.



Mrs C Smith
Principal



ADVERTISEMENT

Teacher of PE - Girls

Closing Date: Monday 20th January 2025

Interviews: TBC

Start date: January 2025

Contract type: Full Time

Salary: MPS/UPS

Suitable for ECTs: Yes

Contract Term: Maternity cover

Our staff are our most valued asset. As a National Teaching School all our staff have access to a wealth of support provided by outstanding practitioners.

The Role

A well-qualified and enthusiastic teacher of Girls PE is required to join a talented department with a strong sporting tradition and a high profile locally.

The successful candidate must be able to teach across the full range of sporting activities as well as GCSE PE and A level Physical Education. The department has emerged as a lead department in a very high performing academy due to a relentless focus on excellent PE pedagogy. We are seeking a teacher who shares this drive for quality first teaching and who has a genuine appetite for CPD. A full commitment to our vast wider curriculum program is expected, with clubs before and after school. The department feel strongly about providing students with exposure to elite sport and adventurous activities, so the successful candidate will be expected to contribute to a calendar of offsite visits.

The specific responsibilities will be determined according to the strengths of the successful candidate

The Academy

Tudor Grange Academy is an outstanding 11-18 comprehensive school situated in South Solihull with a roll of approx. 1700. The school was inspected by Ofsted in June 2014 who judged it to be outstanding overall and for each of the four main areas the school was categorised as outstanding. Tudor Grange is committed to delivering a high-quality educational experience for all its students; it is also committed to sharing its experience and expertise with other educational institutions to raise attainment for all students. To this end we are a Teaching School Hub, Languages Hub, Maths Hub and a Research School. We have also been awarded World Class School status.

If you join us, you will benefit from:

- Teaching students who are well motivated
- Strong parental support
- An excellent induction programme
- Access to excellent professional development

Local Area

Solihull is the home of designer-brand shopping, idyllic rural villages, fine dining, fabulous hotels and home to the National Exhibition Centre and Genting Arena, which hosts an array of spectacular live events.

Still quaint, the town is dotted with historic architecture including timber-framed Tudor houses and shops and nearly three-quarters of the borough is defined as Green Belt. Solihull is surrounded by picturesque countryside.

Birmingham Airport is just 10 minutes away and Birmingham International station and Solihull station both provide excellent transport links across the country.

Staff Wellbeing

We actively place staff wellbeing at the centre of everything we do. In our experience, happy teachers make a happy school. Our staff are our single biggest asset, and the success of our students depends on them. So we take care of, and invest in them, properly! A few of the things we offer are:

- A comprehensive CPD programme for all staff whether they are in the early stages of their career or aspiring leaders
- Paid lunchtime duties
- A supportive, open and approachable leadership team
- Friendly colleagues who are always happy to help each other

We really value our staff and will do whatever we can to meaningfully demonstrate that.

Staff Incentives

- Staff activities including: fitness classes, sports clubs and book groups
- Free tea, coffee and biscuits
- On-site parking for staff
- The Academy participates in the childcare voucher scheme and cycle to work scheme
- Access to our Employee Assistance Programme and school counsellor

Teaching School Hub

Having been a Teaching School Hub for many years, in 2021 we were designated as a one of the 87 Teaching School Hubs. We are delighted to be contributing to system led school leadership across our local region (WM4 – Solihull, Redditch, Stratford and Bromsgrove).

The Teaching School Hub plays a key role in The Early Careers Framework (ECF), National Professional Qualifications (NPQs), professional development and Initial Teacher Training (ITT). The aim is that the Teaching School Hub will be the first port of call for teachers and leaders at all stages of their career, in all phases of education, for high quality, research led professional development.

Research School

In 2023, we formed a new Research School in collaboration with the Education Endowment Foundation (EEF). Our main role will be to support schools to use evidence to improve teaching practice. We will provide local and regional support to other schools by communicating research evidence and supporting the translation of this into practice through training, exemplification and school-to-school support. This is an exciting opportunity and we welcome staff engagement in the work of the Research School.



Languages Hub

In September 2023, Tudor Grange Academy Solihull was thrilled to announce its selection as a lead school in the #LanguageHubs initiative, an integral part of the National Consortium for Languages Education (NCLE) to enhance language education quality in England.

The UK government has designated the first 19 schools to oversee the newly expanded network of language hubs across England, backed by a £14.9 million investment to disseminate exemplary language teaching practices and bolster language exam participation. The NCLE, a collaboration between UCL, the British Council, and the Goethe Institute, will oversee the scheme.

Among the inaugural Language Hubs unveiled by the Department for Education (DfE), Tudor Grange Academy School Solihull joins a pioneering group of 19 schools. These institutions will collaborate to establish the first 15 hubs, with four corners jointly led by two schools.

Maths Hub



Origin Maths Hub was established in 2019 and is based at TGAS. Many of our teachers are involved in maths hub work.

Origin Maths Hub is the government-funded local Maths Hub for Solihull, Coventry and Warwickshire. The Maths Hub is a community of teachers, schools and other education professionals/organisations, offering free mathematics professional development opportunities for schools and teachers, in line with the national Maths Hub programme.

We work collaboratively (with teachers and settings from Early Years to Post 16 and Higher Education) to make sustainable and lasting changes that improve children's and learners' life chances by enhancing their experiences, attitudes and outcomes in learning mathematics.



Recruitment and Selection Policy and Procedure

Safer Recruitment

The recruitment process is robust in seeking to establish the commitment of candidates to support the school's measures to safeguard children and to identify, deter or reject people who might pose a risk of harm to children or are otherwise unsuited to work with them. The successful applicant will be required to undertake an Enhanced DBS check. All applications will be considered on their merit and the post will be offered subject to the usual health and criminal record clearance. We are committed to safeguarding and promoting the welfare of children and young people and expect all staff and volunteers to share this commitment.

Canvassing

Canvassing any member of staff, or governor, either directly or indirectly, is prohibited and will be considered a disqualification

Relevant policies

Safeguarding Children Policy

Recruitment and Selection Policy and Procedure

Equality and Diversity Policy

The academy reserves the right to withdraw the advert prior to the closing date.

PHYSICAL EDUCATION AT TUDOR GRANGE ACADEMY SOLIHULL

The school enjoys some excellent facilities which include a multipurpose sports hall, a gym and six tennis courts. Additionally, there are two full-sized rugby pitches, a 3G football pitch and a cricket pitch which has been developed in partnership with Olton West Warwick's Cricket Club who maintain the pitch in return for use of the facilities.

The PE curriculum offered is broad and balanced where groups, which are predominantly single sex, are taught a full range of activities. In key stage 3 students follow a traditional curriculum and are set by ability, this is mirrored in key stage 4 before they select a more personalised pathway to ready them for managing their own physical activity and leading a healthy lifestyle.

Wider-curricular activities are many and varied and take place before school, after school. They include sports such as rugby, football, cross country, basketball, tennis, athletics, badminton, netball, rounders and cricket handball and dodgeball. The school has always been strong at sport with many district, regional and national representatives. Duke of Edinburgh is a particular strength with significant numbers of pupils achieving Bronze, Silver and Gold awards.

Courses Offered

GCSE Physical Education has been taught since 2005 and has achieved extremely good results. This year students achieved an outstanding 93% 9-4 with 43% 7-9. It is usual for at least two sets of students to take this option and it is proving to be an ever increasingly more popular selection with our students on a year on year basis. A Level PE is offered to our sixth form students and we have a good number of students continually selecting this option. This year our A Level PE results were 100% A*-C with a Value Added score of 0.4, again, one of the best in the Academy. The PE department experiences continual success with strong results and are extremely proud of all their students' achievements.

MAIN SCALE TEACHER JOB DESCRIPTION

Core Purpose

- To carry out the responsibilities as a subject teacher, PSHE teacher and form tutor, supporting the ethos and vision of the Academy
- To maximise the achievement of students they teach
- To be committed to safeguarding and promoting the welfare of young people

Core Qualities

- Clear and consistent vision and values
- Ability to motivate and empower others
- Positive attitude to continuous improvement
- Leading by example
- Clear and consistent communication skills

Core Responsibilities

- To meet all Teacher Standards and ensure that any statutory curriculum requirements are met.
- To teach challenging, engaging, well-organised lessons and sequences of lessons across the age and ability range.
- To ensure that the needs of all learners are taken into account and relevant guidance and legislation is implemented.
- To have the highest reasonable expectation of individual student performance.
- To set, mark and assess student work as per Academy and department policies.
- To share in the development of schemes of work and engaging resources for students.
- Ensure that published Academy targets for students' achievement are understood and that progress is monitored and evaluated.
- In liaison with the Curriculum Leader / Lead Teacher and Student Achievement Support Managers, identify students who are underachieving and where necessary create and implement effective plans of action to support those students.
- To establish a purposeful and safe learning environment where students are inspired by the subject and can demonstrate consistently thoughtful, ethical behaviour with positive learning habits and consideration for others.
- To be proactive in developing their own professional learning, including participation in the quality assurance and performance management process.
- To be a form tutor and carry out all related duties
- To carry out a share of supervisory duties in accordance with published schedules and to promote high standards around the Academy.
- To hold positive values and attitudes and uphold the reputation of the Academy both locally and nationally.

Outcomes

- High standards of achievement for all students
- Become part of a highly motivated and effective subject team
- Become an excellent classroom practitioner
- Become part of the Tudor Grange community

Outcomes

- High standards of achievement for all students
- Highly motivated and effective team
- Excellent practitioners
- Effective teamwork
- A reputation as a centre of excellence
- Strong contributions to the enrichment of the curriculum for all students

PERSON SPECIFICATION

CRITERIA	ESSENTIAL	DESIRABLE
Qualifications	<ul style="list-style-type: none"> • Good Honours Graduate with QTS or as required by the DfE 	<ul style="list-style-type: none"> • Experience of further study
Experience	<ul style="list-style-type: none"> • A successful teaching record either as a trainee or experienced teacher • Experience of working with students of all abilities at KS3 and KS4 	<ul style="list-style-type: none"> • Experience of teaching subject at A Level
Skills	<ul style="list-style-type: none"> • Skills set as outlined in the Teachers' Standards 	<ul style="list-style-type: none"> • Outstanding subject and curriculum knowledge • Evidence of significant progress and outcomes for children
Professional Development	<ul style="list-style-type: none"> • Commitment to continuing personal and professional learning development 	<ul style="list-style-type: none"> • Evidence of Professional Learning relevant to the role
Leadership Skills and Values	<ul style="list-style-type: none"> • Ability to inspire, motivate and challenge students • Commitment to the pursuit of excellence in educational standards • Ability to communicate effectively with colleagues, students, parents and external agencies • Commitment to and promotion of co-curricular opportunities 	<ul style="list-style-type: none"> • Potential for further leadership role
Knowledge & Understanding	<ul style="list-style-type: none"> • Demonstrate good subject and curriculum knowledge including the national curriculum • Know how to secure outstanding progress and outcomes by students adapting teaching as needed 	
Student Involvement	<ul style="list-style-type: none"> • Commitment to student involvement • Personal commitment to listen to student voice • Focus on individual student's needs and development of independent learning 	<ul style="list-style-type: none"> • Evidence of student involvement
Personal Attributes	<ul style="list-style-type: none"> • Flexibility to cope with diverse needs of the post • Resilience to work under pressure • Positive, tenacious and optimistic • Ability to quickly establish positive relationships with students, staff and parents 	<ul style="list-style-type: none"> • Initiative and ability to create new processes and practices to raise standards

ABOUT TUDOR GRANGE ACADEMY

Tudor Grange Academy is an outstanding 11 – 18 comprehensive school situated in South Solihull with 1700 students (including 320 in the sixth form). The school was inspected by Ofsted in June 2014 who judged it to be outstanding.

Tudor Grange is committed to delivering a high quality educational experience for all its students; it is also committed to sharing its experience and expertise with other educational institutions to raise attainment for all students. To this end we are a National Support School. We have also been awarded World Class School status (one of only 16 schools nationally to have been given this status).

Tudor Grange is designated as a Teaching School Hub. This places the academy at the heart of the school improvement agenda and we are a key player in the educational change agenda. This offers our staff the chance to participate in, and facilitate courses for other professionals.

Tudor Grange Academy in Solihull has always been a beacon of excellence. Its focus on continuous improvement and belief that high quality teaching and learning is at the core of great schools has ensured that it has maintained its outstanding provision year on year.

Having secured outstanding provision for the students in their care, the Governors of Tudor Grange School, as it was, developed an ambition: every child deserves an outstanding education, not just the children within their school. They supported staff within Tudor Grange to engage fully in a wide range of national and international partnerships focussed on improving provision in schools. The Academies programme then provided an opportunity for them to sponsor a school in challenging circumstances, taking full responsibility for the quality of this provision and therefore potentially enabling them to realise their ambition.

In September 2009 Tudor Grange School, Solihull sponsored Tudor Grange Academy Worcester. The school is now oversubscribed and the school of choice within its local community. This successful sponsorship and effective school to school collaboration gave rise to the vision for Tudor Grange Academies Trust: a group working together in a model of meaningful, focused collaboration to achieve excellence in their schools.

The Trust, as at January 2022, is a Trust of twelve schools: five secondary schools, one all through academy and six primary academies. Restlessness characterises all our academies: we are not afraid to challenge complacency and weaknesses identified are seen as opportunities to improve, the energy and drive for the ceaseless journey comes from our key ambition: 'Every child deserves an outstanding education.'

Working within a Trust offers opportunities for up to date training, cross curricular working, bespoke professional development pathways. All staff are encouraged to better themselves and we collectively celebrate success in a vibrant and healthy working community.

KEY STAGE 4 OUTCOMES 2023

Progress 8	TBC
Attainment 8	61.79
% students achieving a grade 5 or above in English and mathematics	77%
% students achieving a grade 4 or above in English and mathematics	92%
English Baccalaureate Average Grade	5.81

KEY STAGE 5 OUTCOMES 2024

A Level Subjects

A* - B	66.4%
A* - E	97%
3 or more A* - E	95%

LEADERSHIP TEAM AND GOVERNORS

Principal

Mrs C Smith

Senior Leadership Team

Mr M Boyle (Associate Principal)

Mr T Pole (Associate Principal)

Mrs J Fitzroy (College Leader)

Mr K Hindley (College Leader)

Miss K Knowles (College Leader)

Miss N Thompson (College Leader)

Mr A Wright (College Leader)

Mr J Bargh (Director of Sixth Form)

Mrs C Young (SEND college leader)

Mrs J Bargh (Associate College Leader)

Chair of Governors

Mrs Helena Mandleberg - Governor

 MIRZAKHANI	 HAWKING	 TURING	 AUSTEN	 DULEEP	 OWENS
College Leaders					
 Mr M Boyle	 Mr K Hindley	 Mrs J Fitzroy	 Mr D Wright	 Miss N Thompson	 Miss K Knowles
Intervention Co-ordinators and Safeguarding Team					
 Miss Kaur	 Ms Khalil	 Miss Harriman	 Miss Walsh	 Mrs Gray	 Mrs Payley
Administrators					
 Mrs Davis	 Ms Lam	 Mrs Abdul-Haqq		 Miss All	 Miss Love

OUR FACILITIES

Tudor Grange Academy Solihull was opened in 1956 as a grammar school for boys. It occupies a site on the west side of Solihull in an extensive area of parkland. Over the years our facilities have been extended and improved to offer our students the very best environment in which to grow and thrive.

The Academy is made up of 2 main buildings with additional specialist buildings for Sport, Music, Teacher Training and Technology. There is also a building on site to accommodate central Trust staff.

- 14 Science laboratories
- Specialist building for Music with rehearsal rooms
- Six ICT suites with state-of-the-art multimedia PCs on a Windows platform
- Whole school network of over 300 PCs
- Student Services block with first aid and meeting rooms
- Large sports centre with sports hall and changing rooms
- Recently refurbished gym and changing rooms
- Extensive sports fields surrounding the site
- Brand new 3G Astro pitch (opened Jan 2022)
- Two cafeteria style dining areas with additional Food Bar in playground
- Two large playgrounds with table tennis tables
- 6th Form Centre with 4 classrooms, study areas and lecture style seating for 50
- 6th Form only Café with study area
- 6th Form Quiet Study Area
- Specialist building for Design & Technology, Art and Business
- Specialist equipment in Design and Technology including 3D Printer, Laser Cutter Microrouter, Sublimation Machine
- A new classroom block (MFL / History) with 14 classrooms



ACADEMIC ORGANISATION

At Tudor Grange Academy, the Tudor Habits are at the heart of everything we do. We believe that developing the whole student is essential and that to flourish in life you need much more than great grades. We set high expectations of every student to ensure that they excel across all aspects of Academy life.

THE LEARNING HABITS

THE CHARACTER HABITS

TEAM TG

THE TUDOR VALUES

- Tolerance & Acceptance
- Unity
- Democracy
- Opportunity for all
- Respect for others' beliefs & the law
- Integrity
- Empathy
- Honesty
- Compassionate
- Responsibility
- Forgive
- Friendly
- Grateful
- Humility
- Kind
- Love
- Trustworthy
- Resilience
- Curiosity
- Pragmatic
- Collaborative
- Creative
- Determined
- Enthusiastic
- Flexible
- Imaginative
- Persevering
- Purposeful
- Resourceful
- Self-Regulated
- Tenacious
- Analytical

Click [here](#) to find about more about Tudor Habits

The philosophy of Tudor Grange Academy Solihull is that each student is entitled to a broad, ambitious and equitable curriculum.

Broad because it allows children to supplement a strong academic core of subjects with a range of artistic and creative subjects

Ambitious because we believe that every child should access a curriculum that provides them with the cultural capital and essential knowledge they need to be educated citizens.

Equitable because every child will access this curriculum, regardless of their background or past experience, and because this universal entitlement means that every child will have the potential to take advantage of a range of opportunities in later life.

Curriculum planning is undertaken by subject experts from across Tudor Grange Academies Trust and is adapted to ensure that it meets the needs of the students at Tudor Grange Academy Solihull. Subject experts have considered what is most valuable about their subject and the curriculum is built around these fundamentals.

Key Stage Three

In Years 7, 8 and 9 students follow a broad, ambitious and equitable curriculum, in line with the national curriculum, including:

- English
- Mathematics
- Science
- Art and design
- Computing
- Design and Technology
- Geography
- History
- Languages (one of French, German or Spanish)
- Music
- Physical Education

In addition, students at Tudor Grange Academy Solihull also study:

- Religious Education
- RSHE
- Citizenship (including careers and Tudor Habits including teamwork, leadership and resilience)
- Healthy Living (including food, nutrition and health)
- Drama

Within this wide range of subjects, students learn the 'fundamentals' – the essential knowledge that students must master and commit to long term memory. These are the essential pieces of information we believe provide students with cultural capital.

Many students have a clear idea of the subjects they like the most and least by the middle of Year 9 and offering some choice at this stage engages the students as partners in their learning and leads to improved outcomes. During year 9, full consultation takes place between staff, students and parents to support curriculum choices.

At the end of Year 9, students are given the opportunity to make curriculum choices and continue their core studies with specialisms. Options are structured in such a way to allow students a free choice. This ensures equity of delivery, with all students having equal access to subjects.

Key Stage Four

In Years 10 and 11, students study a wide range of GCSE qualifications, including:

- English
- Mathematics
- Science
- Geography or History
- Languages (at least one of French, German or Spanish)
- Physical Education
- RSHE
- Ethical studies (including RE, citizenship)

Information about KS4 GCSE courses can be found for each subject under the curriculum area of the website.

Key Stage Five

The curriculum at Post 16 is designed to prepare students for both university and the world of work. Each post-16 student has their own specific goal and ambition and we ensure that each student has a personalised curriculum that meets their individual requirements. Students choose from a diverse range of qualifications so that they are able to participate in challenging and enjoyable courses.

Further information can be found [here](#) on our dedicated sixth form pages.

PASTORAL ORGANISATION

Students are looked after in one of six Colleges; Brunel, Darwin, Edison, Morse, Newton and da Vinci. Each college has a College Leader, a College Intervention Co-ordinator (CIC) and a College Administrator.



When a student starts at Tudor Grange they are placed in one of 66 vertical tutor groups. Each tutor group has students from years 7 – 11 and is looked after by a tutor. Their tutor will monitor all aspects of the student's school life and is the first port of call for parents contacting the Academy.

Our Student Services offers a range of facilities for our young people including a first aid room with a dedicated first aider available all day every day.

EXTRA CURRICULAR ACTIVITIES

As an Academy we feel strongly that the development of motor and interpersonal skills is enhanced by the opportunities and experiences students have outside of the classroom. Hence, we provide a diverse breadth of activities that are part of a weekly timetable for students to opt into. These activities run before, during or after school and are delivered by willing and specialist staff who want to relay their knowledge and passion.

The list below shows just a small selection of the programme on offer (example programme is included at the back of the pack):

- Sports Teams including football, rugby, netball, hockey, cricket, basketball, handball and trampolining for both boys and girls
- Various music clubs including choir and orchestra
- Debate club
- Art and photography
- Drama
- Dance
- STEM Club
- Combined Cadet Force (CCF)
- Chess club
- Cooking club



WHAT DO TEACHERS SAY

Tudor Grange is a school wher staff are professional and hardworking, setting themselves high standards which in turn rub off on our students

Ed, Teacher of Mathematics

Tudor Grange is a progressive, dynamic and exciting place to work.

The leadership team, staff and the students are always seeking excellence and consistently striving to improve approaches in teaching and learning. There are always opportunities to develop, learn and grow as a practitioner.

Emily, Teacher of English

I like the '**yes culture**' that exists within the school, which means that those with the passion and drive to introduce new ideas, from departmental level to whole school, are given the confidence to move forward.

Tom, Teacher of History

EDUCATIONAL VISITS

Tudor Grange Academy are able to offer a range of educational visits to our students to enhance their learning and give them opportunities to develop new skills and interests.

Our teaching and support staff are integral in offering these experiences to the students, and we are proud of the professionalism and commitment they display.

Below is a sample of some of the trips that have been available to our students in recent years.

Year 7 Adventure Day

Held in October with team building and sports activities. Giving students an opportunity to build new relationships with students and staff.

Duke of Edinburgh Programme

Bronze, Silver and Gold Duke of Edinburgh awards are offered to our students in Year 9 and above. Students undertake activities in Volunteering, Physical and Skills and take part in two walking/camping expeditions. This programme builds confidence and independence and is widely recognised by employers and further educational establishments.

Sixth Form Visit to CERN

A level science students spend a weekend in January visiting the world famous CERN site in Switzerland, with recreational and cultural activities included, staying in hotel accommodation.

European Ski Trip for Years 9 to 13

This is a five day trip held in February half term, where students have an opportunity to take part in ski or snowboarding lessons, along with other recreational activities, such as bowling or ice-skating, staying in hotel accommodation.

European Football, Rugby, Netball Tour

GCSE PE students take part in European sporting fixtures during May half term, visiting theme parks and sporting stadiums in their leisure time, with accommodation in hotels.

Year 8 European PGL Trip

A nine day camping trip taking place in July, with a variety of water sports activities.

GCSE Visual Arts Trip to Europe

To help develop their drawing and photography skills, GCSE Visual Arts students can take part in this 4 day trip, staying in hotel accommodation, visiting museums and historical locations.

GCSE MFL Trip to Europe

This five day trip to Europe gives GCSE MFL students an opportunity to visit a country where the foreign language they are studying is spoken and to experience the cultural and recreational activities of the region.

EXTRA-CURRICULAR ACTIVITIES

An example timetable is below.

WIDER CURRICULAR PROGRAMME



Monday Before School	Tuesday Before School	Wednesday Before School	Thursday Before School	Friday Before School
	FOOTBALL Years 10 & 11 3G 7.30 am – 8.15 am FOOTBALL Years 10 & 11 Girls 3G 7.30 am – 8.15 am NETBALL Years 8 & 9 Sports Hall 7.30 am – 8.15 am STRING ENSEMBLE C2 7.45 am – 8.30 am	SENIOR DANCE Oak Hall 7.30 am – 8.15 am BASKETBALL KS4 Sports Hall 7.30 am – 8.15 am TABLE TENNIS KS3 Gym 7.30 am – 8.15 am	SENIOR & JUNIOR DANCE Oak Hall & Gym 7.30 am – 8.15 am BASKETBALL KS3 Sports Hall 7.30 am – 8.15 am FOOTBALL Years 7, 8 & 9 Girls 3G 7.30 am – 8.15 am FOOTBALL Years 10 & 11 (All Invited) 3G 7.30 am – 8.15 am	SENIOR DANCE Oak Hall 7.30 am – 8.15 am BADMINTON Sports Hall 7.30 am – 8.15 am TABLE TENNIS KS4 Gym 7.30 am – 8.15 am
Monday After School	Tuesday After School	Wednesday After School	Thursday After School	Friday After School
FOOTBALL Year 7 3G 3.00 pm – 4.15 pm NETBALL Years 7 Sports Hall 3.00 pm – 4.15 pm RUGBY All Years Boys & Girls 3G 3.00 pm – 4.15 pm COMPOSITION Year 11 C1 3.00 pm – 4.00 pm CHESS CLUB All Years OG3 3.00 pm – 4.00 pm WRITE WORD All Years OS7 3.00 pm – 4.00 pm ENGLISH SOCIETY All Years OS5 3.00 pm – 4.00 pm	FOOTBALL Years 8 & 9 3G 3.00 pm – 4.15 pm TRAMPOLINING PE Students Sports Hall 3.00 pm – 4.15 pm GEOGRAPHY CLUB Years 7, 8 & 9 WS1 3.00 pm – 4.00 pm GARDENING CLUB All Years WG8 > Garden Area 3.00 pm – 4.00 pm * Not on if the weather is bad LGBT CLUB All Years Week B Only WG16 3.00 pm – 4.00 pm AMNESTY INTERNATIONAL CLUB All Years Week A Only MF4 3.05 pm – 15.45 pm SCIENCE CLUB All Years WF9 3.10 pm – 4.00 pm WARHAMMER CLUB All Years P7 3.00 pm – 4.00 pm OPEN STUDIOS Year 11 P5 & P10 3.00 pm – 4.00 pm	COMBINED CADET FORCE CCF Building 3.00 pm – 5.00 pm	DODGEBALL All Years Gym 3.00 pm – 4.15 pm LACROSSE All Years 3G 3.00 pm – 4.15 pm NETBALL Year 10 – Year 13 Sports Hall 3.00 pm – 4.15 pm CHOIR All Years C1/C2 3.00 pm – 4.00 pm JEWELLERY CLUB All Years P8 3.00 pm – 4.00 pm ART CLUB KS3 P4 3.00 pm – 4.00 pm F1 in SCHOOLS Year 10 P7 3.00 pm – 4.00 pm COOKING CLUB All Years (sign up > Mr Jennings) OF2 3.00 pm – 4.30 pm POLYDRON CLUB All Years OF6 3.05 pm – 4.00 pm HISTORY CLUB All Years MF3 3.00 pm – 4.00 pm	MODERATIONS/ TRAINING Year 10 3.00 pm – 4.15 pm STUDY SUPPORT Year 11 3.00 pm – 4.15 pm ORCHESTRA All Years C1/C2 3.00 pm – 4.00 pm DEBATE CLUB All Years OS9 3.00 pm – 4.00 pm READING ROOM All Years OS5 Lunchtime

● Wider Curricular Sports ● Wider Curricular Programme ● Wider Curricular Music

Autumn 2023



Tudor Grange
The Elms

We are proud to have been able to open The Elms in January 2021

What is The Elms and who is it for?

The Elms is an Additionally Resourced Provision (ARP) at TGAS in partnership with Solihull Local Authority.

It is an eight place, placement provision for students in Key Stage 3 (Years 7 – 9) with SEMH needs. Specifically, it is for students who are currently not accessing school due to SEMH needs, specifically Emotionally Based School Non-Attendance (EBSN).

How will the placement work?

Students will remain on the roll of their home school but will be placed at The Elms for a period of time, up to two terms.

During this time, specialist staff will work with the student to support a successful transition back to the home school (or to a more appropriate setting, if the home school is not an appropriate option).

A small nurturing environment at The Elms

The Elms has a dedicated entrance and car parking.

The bespoke building has three break out rooms that can be used for meetings with families, professionals, specialist support sessions or one to one sessions with students.

There is a fully equipped kitchen where students can store food in the fridge or be supported to cook their own meals at lunchtimes. The main room will be used for communal dining as well as for more formal teaching sessions.

A second teaching area is set up as a mini-classroom so that students remain familiar with the classroom environment.

There is a large outdoor area that can be used for social time, outdoor learning and as a safe space for students. We want to work with students to create areas that they have ownership of, such as an allotment, herb garden or forest school area.

Curriculum at the Elms

To aid transition back to mainstream education, students will have access to a broad, equitable and ambitious curriculum at The Elms. Many of our subject teachers teach in The Elms and this is a wonderful experience of teaching in an alternative provision.

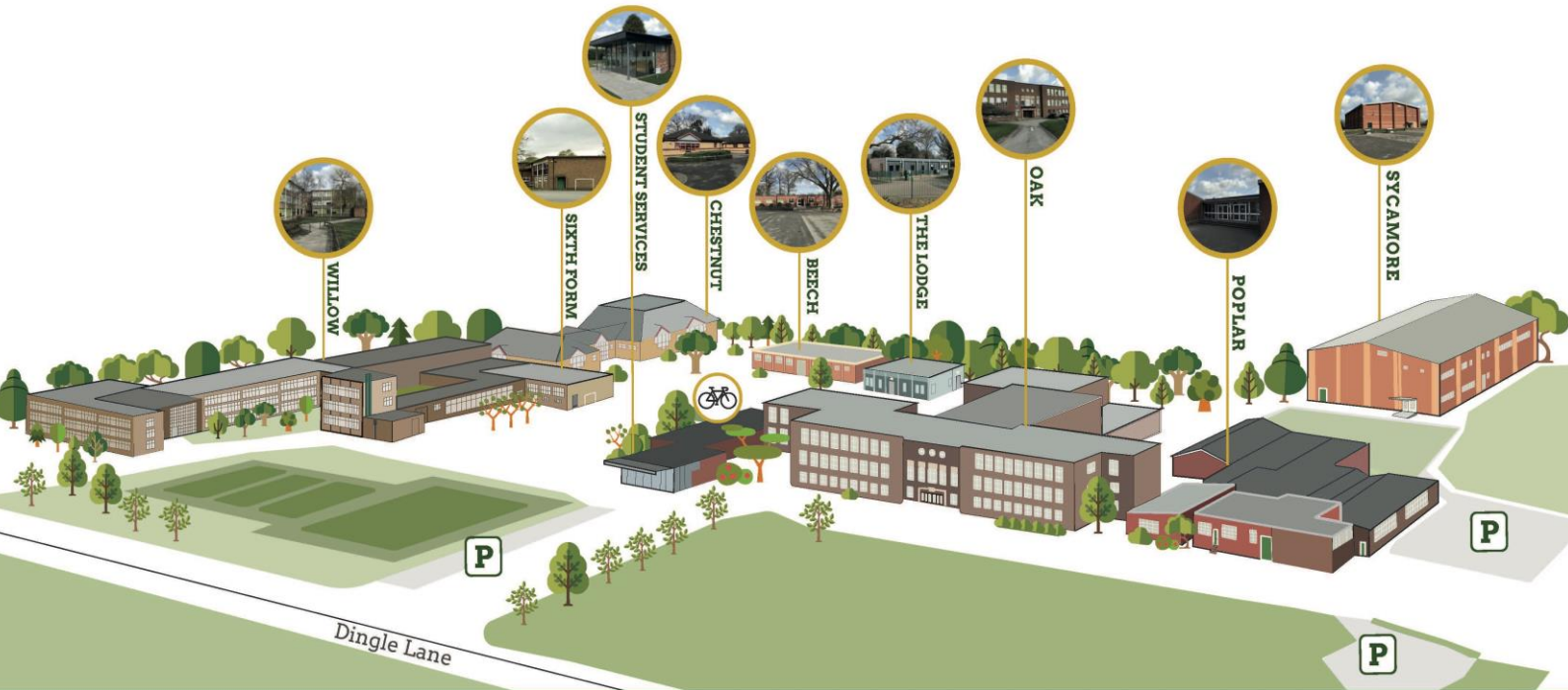

OAK: Admin, Maths, MFL, IT, History, Food
CHESTNUT: Music, LRC
BEECH: Geography
THE LODGE: Teaching School
POPLAR: Business, Drama, Art, Design & Technology, ICT
WILLOW: Sixth Form, English, Science, RE, Psychology, Sociology, Media
SYCAMORE: Sports Hall

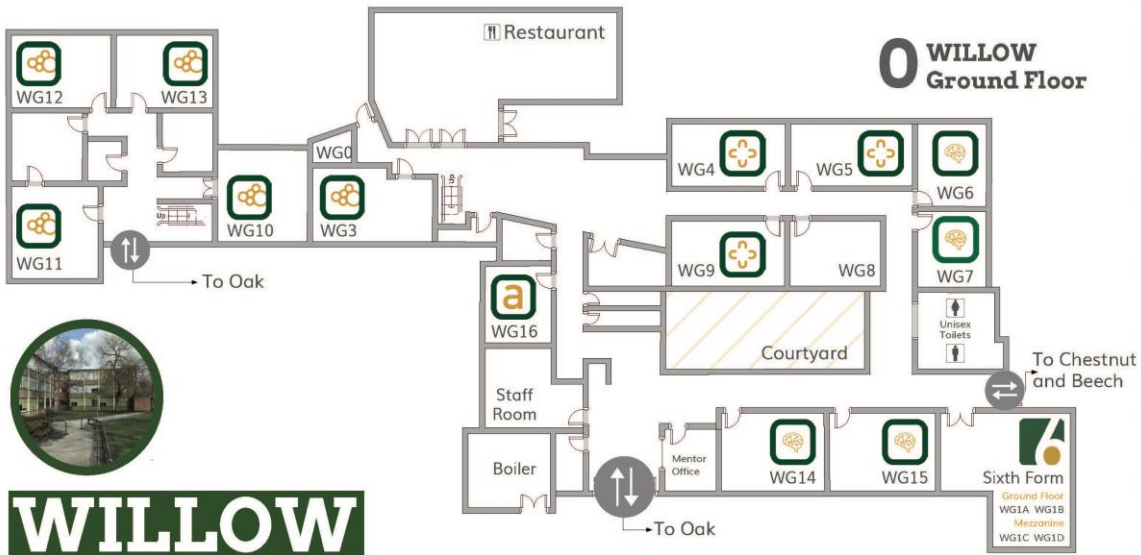

DRAMA	ART	MUSIC
HISTORY	ENGLISH	MFL
P.E.	GEOGRAPHY	SCIENCE
MATHS	FOOD	ICT
IT	PSYCHOLOGY	R.E.
BUSINESS STUDIES	DESIGN & TECHNOLOGY	SIXTH FORM

WILLOW

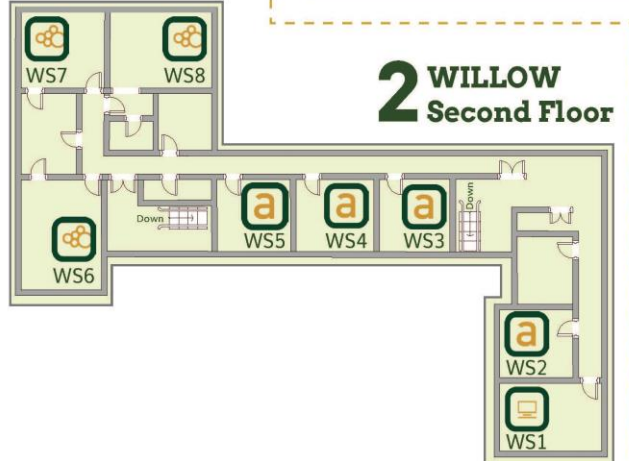
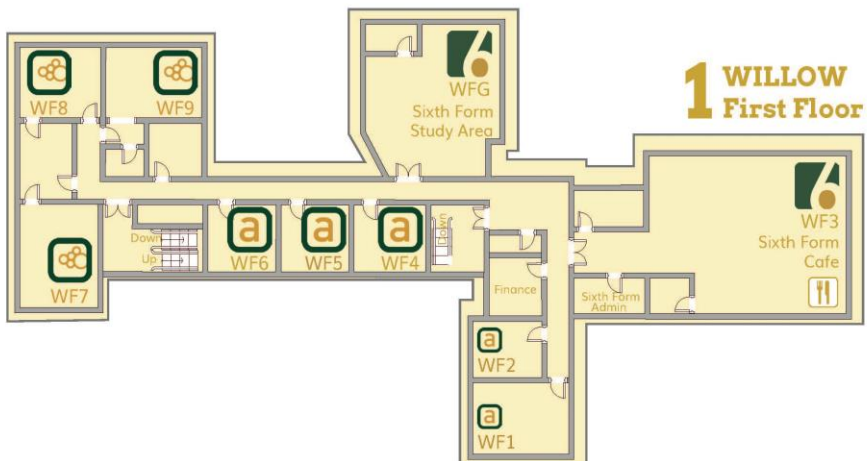

DRAMA	ART	MUSIC	MATHS	R.E.	BUSINESS STUDIES
HISTORY	ENGLISH	MFL	PSYCHOLOGY	ICT	DESIGN & TECHNOLOGY
P.E.	GEOGRAPHY	SCIENCE	FOOD	IT	TEACHING SCHOOL

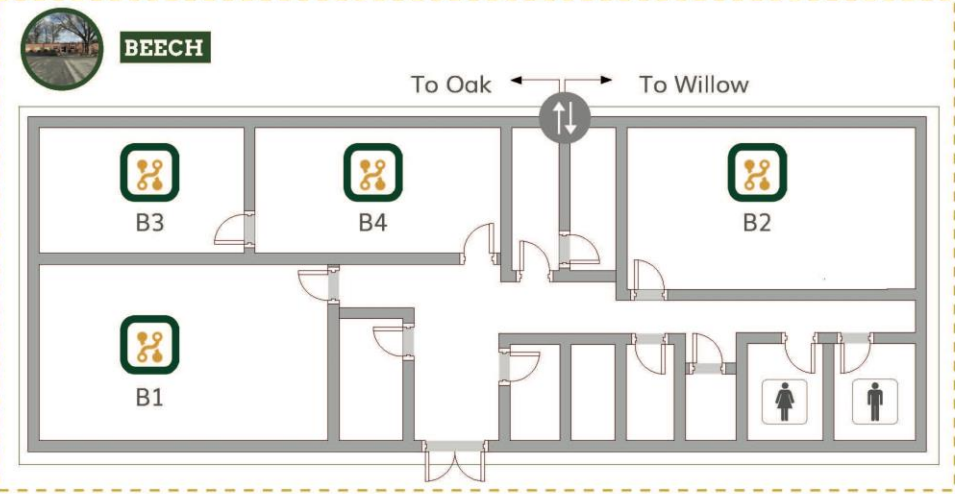
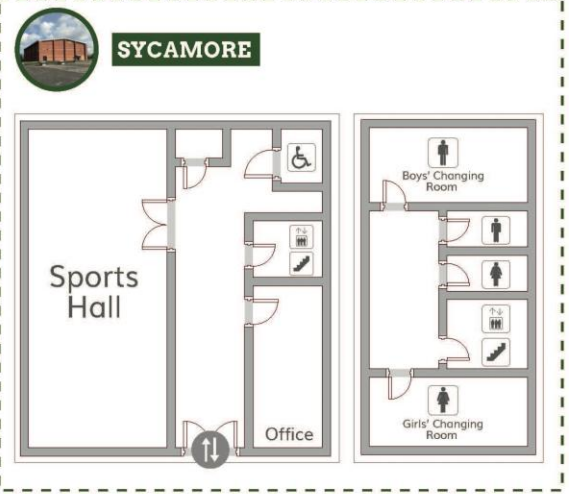
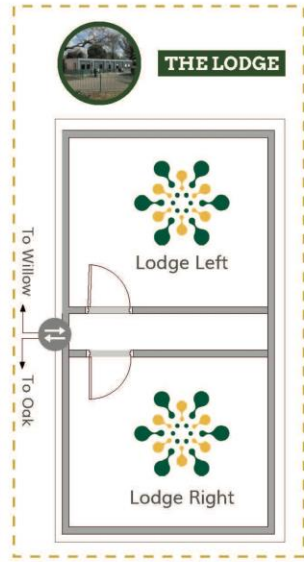
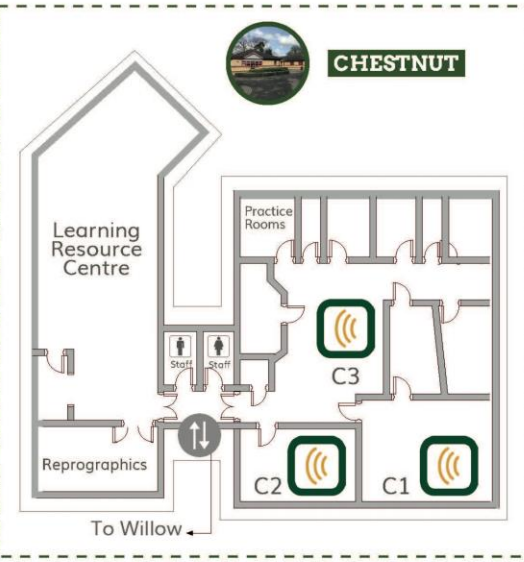
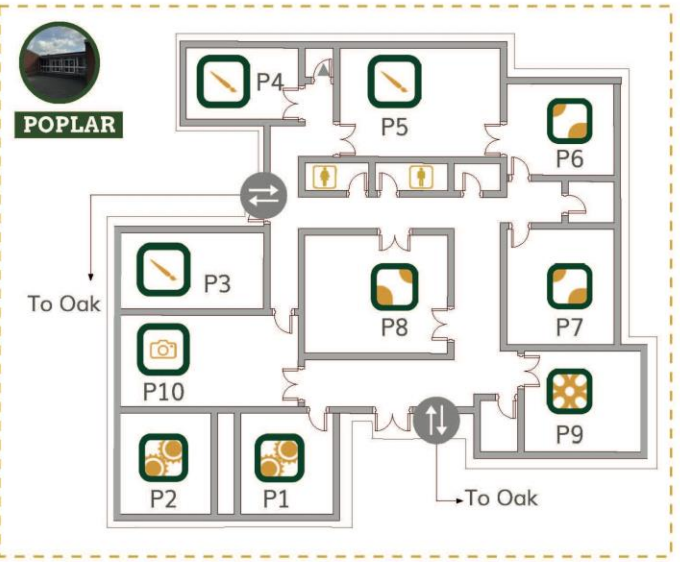
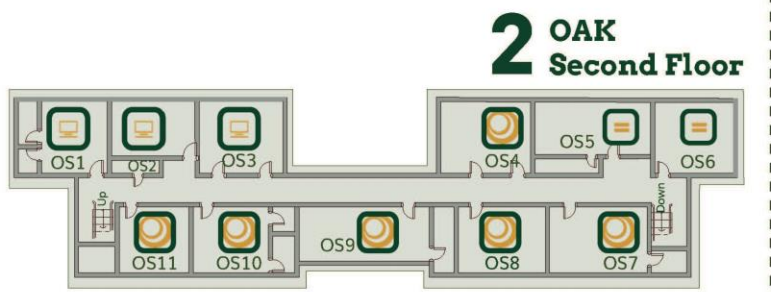
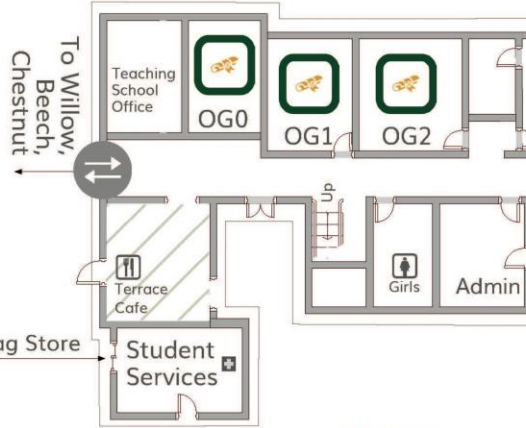
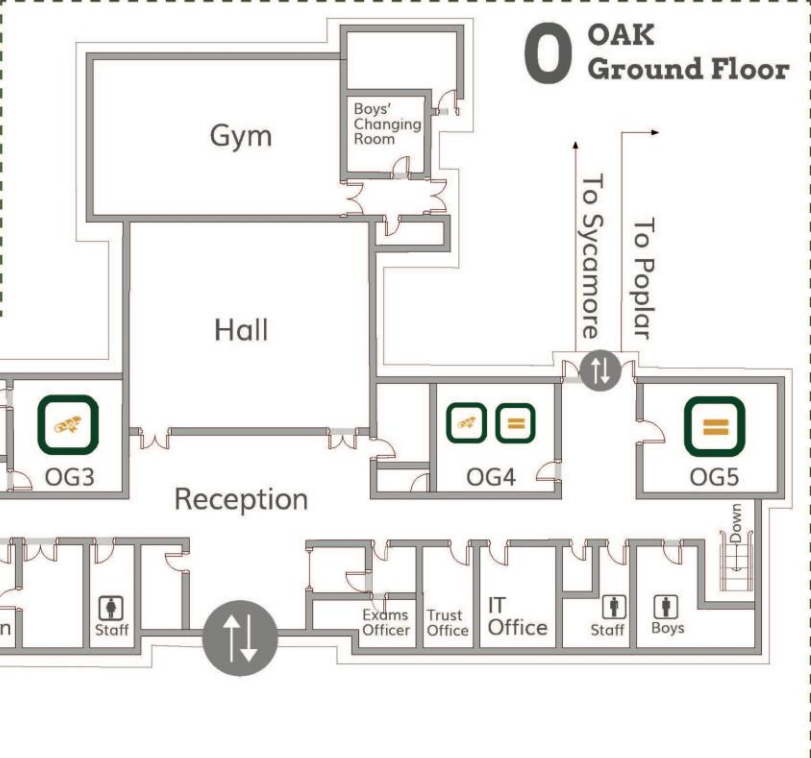

We Are Here...

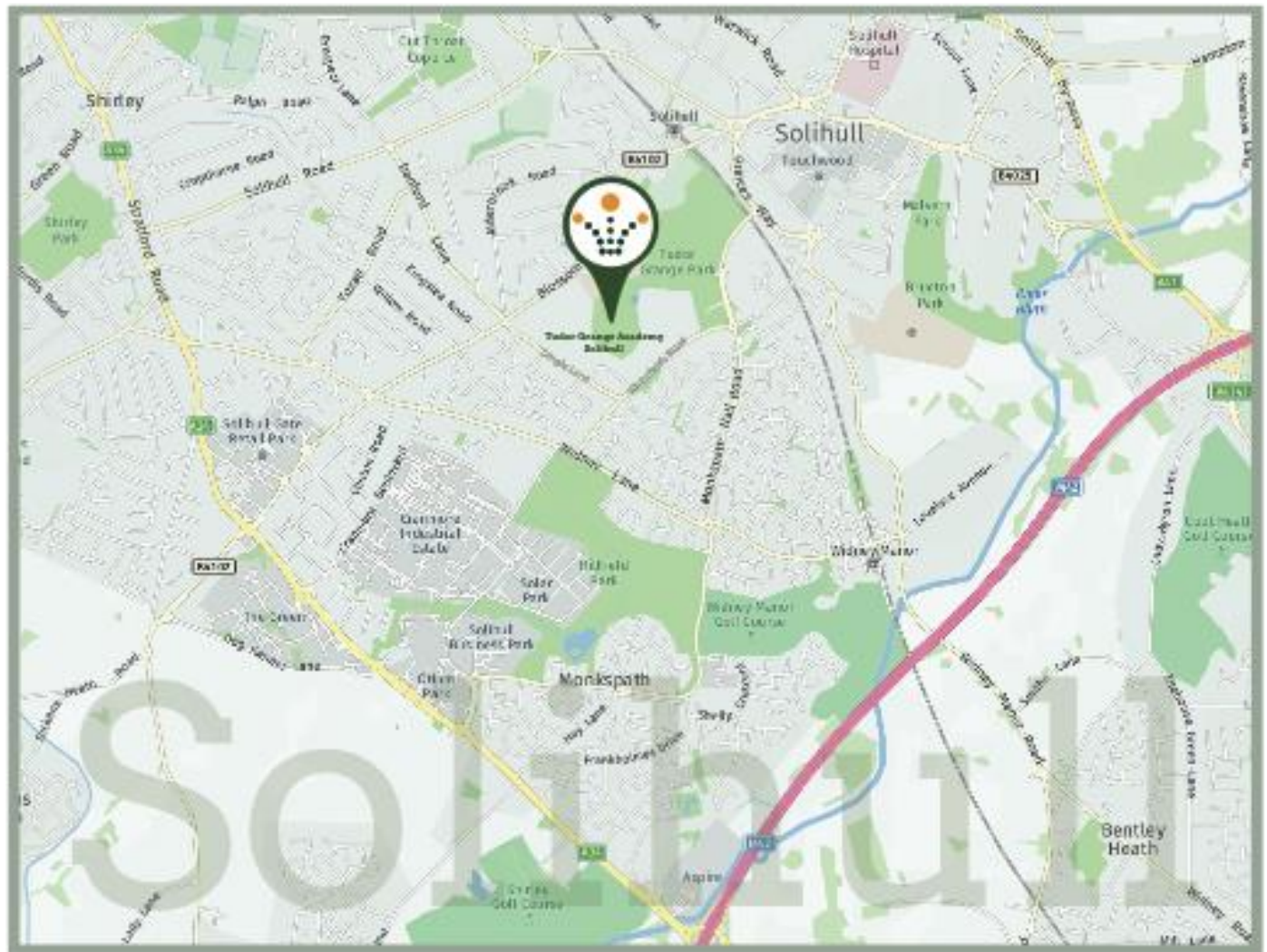

Directions from M42 Junction 4

1. Leave motorway at Junction 4 and follow exit for A34 (Stratford Road) Shirley
2. Stay on A34 until the fourth roundabout (Porcelanosa on your left as you come to island) and turn right onto B4102 (Marshall Lake Road)
3. Stay on B4102 past retail parks up to traffic lights
4. Continue at traffic lights (Marshall Lake Road changes to Blossomfield Road)
5. At the next island turn right into Dingle Lane
6. Tudor Grange Academy is along Dingle Lane, second drive to your left
7. Please press the intercom at the barrier to speak to Reception to gain entry to park onsite
8. Reception is located at the bottom of the drive, on the right through the large oak doors



Tudor Grange Academy Solihull

Dingle Lane, Solihull, B91 3PD

T.: 0121 705 5100 F.: 0121 703 8226

office@solihull.tgacademy.org.uk

www.solihull.tgacademy.org.uk